

SKYLINE

The Skyline system is the flagship of the Rollease Acmeda product line offering a sleek profile with quiet solutions ideal for both residential & commercial applications.

AESTHETIC FEATURES

- Minimal light gaps
- Color-matched brackets and covers

ASSEMBLY / PRODUCTION FEATURES

- Greater flexibility in installation with spring-loaded pin end
- Crown, drive and adapters available to suit a variety of tube sizes
- Works with all current Rollease Acmeda hardware systems

FUNCTIONAL BENEFITS

- Internal spring arrangement ensures remarkably smooth operation
- Spring-loaded pin ends are forgiving in installation
- Hooks on clutches ensure very fast installation
- Long-lasting product with limited life time warranty
- Exterior versions available

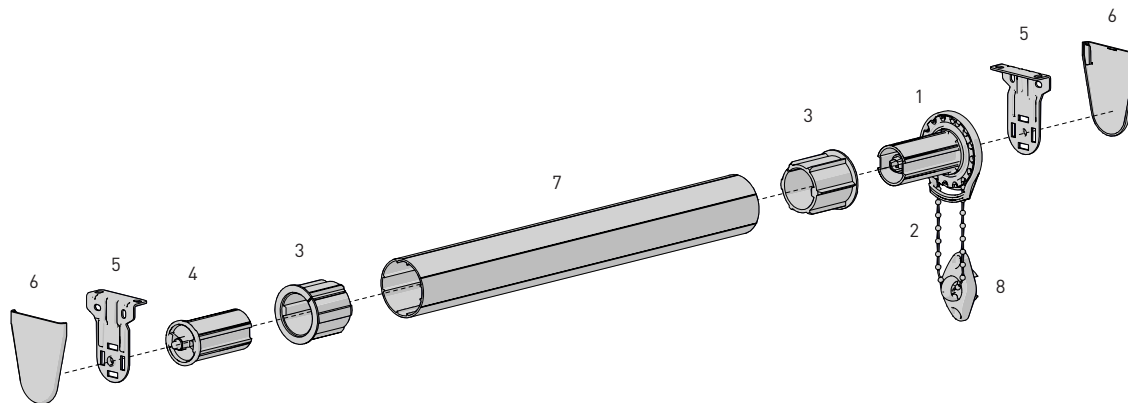

SYSTEM INDEX

- 1 Skyline Clutch
SL##H##xx
- 2 Chain
RBC45Mxx - Metal
RBC6MMxx - Plastic
- 3 Skyline Adapter
SLA##xx
RA2##xx
- 4 Skyline Pin End
SLPEHD53xx
SLPEV####xx
SLPE4##xx
- 5 Skyline Bracket
SLB6##xx Standard
SLNB6####xx Narrow
SL01-0306-xxx###
- 6 Skyline Bracket Cover
SLBC##xx Standard
SLNBC##xx Narrow
RB08-4151-xxx###
- 7 Aluminium Tube
RTEA#T16
- 8 Tension / Hold Down Devices
RE0051203
RB91-1336-xxx000 + RB91-1337-xxx000

- Size
xxx- Color

COLOR RANGE



PRODUCT OPTIONS

GALAXY CLUTCH

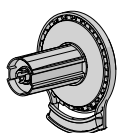

SPRING ASSIST

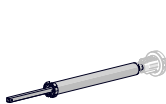

DOUBLE BRACKET

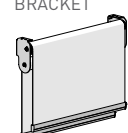

PRECISION WAND

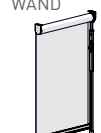

CASSETTE 80/100/120

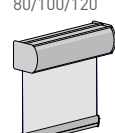

FASCIA 3"/4"/5"

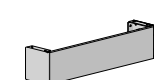

LINK SYSTEM

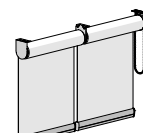

POCKETS

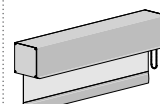

PELMET 95

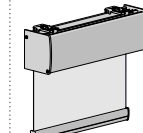

CF90

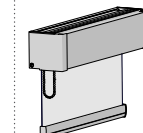

MOUNTING RAIL

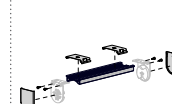

SYSTEM UPGRADES (SLBC##xx Standard / SLNBC##xx Narrow only)

SYSTEM UPGRADES (SL01-0306-xxx### only)

SPECIFICATIONS

DEDUCTION TABLE

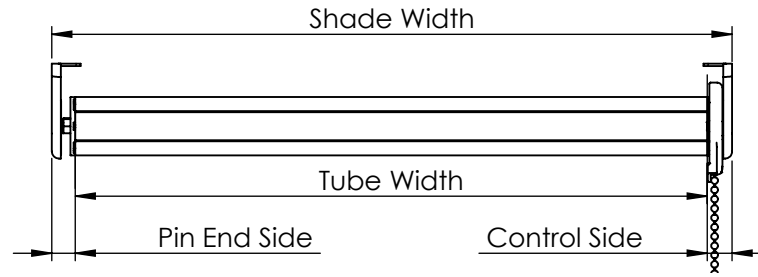

	PIN ENDS			PER COVER		PER BRACKET	ADAPTERS		
	CLUTCH SIDE	PIN END SIDE	HD PIN END	BRACKET COVER for SLB6XXX / SLNB6XXX	BRACKET COVER for SL01-0306-xxx###	SLB6xxx / SLNB6xxx / SL01-0306-xxx###	SLA4xxx	RA25xx	Other*
SL5/SL20	1/2" [12mm]	5/16" [8mm]	3/8" [9mm]	1/16" [2mm]	1/16" [1mm]	3/16" [5mm]	1/16" [2mm]	1/16" [1mm]	0" [0mm]
SL10/SL15	3/8" [10mm]	5/16" [8mm]	3/8" [9mm]	1/16" [2mm]	1/16" [1mm]	3/16" [5mm]	1/16" [2mm]	1/16" [1mm]	0" [0mm]
SL30	1/2" [13mm]	5/16" [8mm]	3/8" [9mm]	1/16" [2mm]	1/16" [1mm]	3/16" [5mm]	1/16" [2mm]	1/16" [1mm]	0" [0mm]
G200	9/16" [15mm]	5/16" [8mm]	3/8" [9mm]	1/16" [2mm]	1/16" [1mm]	3/16" [5mm]	1/16" [2mm]	1/16" [1mm]	0" [0mm]
G400	1/2" [13mm]	5/16" [8mm]	3/8" [9mm]	1/16" [2mm]	1/16" [1mm]	3/16" [5mm]	1/16" [2mm]	1/16" [1mm]	0" [0mm]

These deductions allow an easy and quick installation (instal the pin end first, then the clutch side)

*All other adapters require no further deductions

MAX HOLD CAPACITY

CLUTCH	LOAD	TUBE	CORD or BEAD CHAIN
SL5	5.6lbs (2.5kg)	1" [25mm]	Both
SL10	11 lbs (5.0kg)	1½" [28mm]	Both
SL15	16.5 lbs (7.5kg)	1½" [28mm]	Both
SL15	12 lbs (5.5kg)	1½" [38mm]	Both
SL20	20 lbs (9.1kg)	1½" [38mm]	Bead
SL20	15 lbs (6.8kg)	2" [50mm]	Bead
SL30	22 lbs (10.0kg)	2" [50mm]	Bead
SL30	18 lbs (8.2kg)	2½" [63mm]	Bead
SL30	14.4 lbs (6.5kg)	3¼" [83mm]	Bead
G200	24 lbs (10.9kg)	1½" [38mm]	Bead
G200	18 lbs (8.2kg)	2" [50mm]	Bead
G200	14.4 lbs (6.5kg)	2½" [63mm]	Bead
G400	40 lbs (18.2kg)	2" [50mm]	Bead
G400	32 lbs (14.5kg)	2½" [63mm]	Bead
G400	25lbs (11.4kg)	3¼" [83mm]	Bead

Please note that the loads are max loads for clutches. Max loads will not produce comfortable pull forces.

TUBE ADAPTER COMPATIBILITY CHART

CLUTCH/ TUBE	1" [25mm]	1-1/8" [28mm]	1-1/4" [32mm]	[40mm]	43mm	1-1/2" [38mm]	2" [50mm]	2-1/2" [63mm]	3-1/4" [83mm]
SL5/SL10	Compatible	Compatible	SLA03x	SLA04x	SLA43x	SLA53x	-	-	-
SL15	-	Compatible	SLA03x	SLA04x	SLA43x	SLA53x	-	-	-
SL20/G200	-	-	-	-	-	Compatible	RA2	RA25	-
SL30/G400	-	-	-	-	-	Compatible	RA2	RA25	RA25

MAX ROLL

BRACKET	MAX ROLL SIZE	SL5/SL10	SL15/SL20/G200	SL30/G400
SLNBxx650xx	2-5/16" [59.0mm]	Compatible	-	-
SLxx660xx	3" [76.2mm]	Compatible	Compatible	-
SLxx680xx	4" [101.6mm]	Compatible	Compatible	Compatible
SLxx690xx	5" [127.5mm]	Compatible	Compatible	Compatible
SL01-0306-xxx040	2-15/16" [74.1mm]	Compatible	Compatible	-
SL01-0306-xxx055	4-1/16" [103.7mm]	Compatible	Compatible	Compatible

