

Skyline 0.7Nm & 1.1Nm | 25mm

The motorized 25mm 0.7Nm & 1.1Nm Skyline roller shade system offers motors for multiple tube diameters to suit a variety of applications. Featuring ARC (Automate Radio Communication), the motorized 25mm 0.7Nm & 1.1Nm Skyline system provides an intelligent, Li-ion battery powered solution.

AESTHETICAL FEATURES

- Thinner 5V Motor Head
- Motor cap to color match with brackets

PRODUCTION & ASSEMBLY FEATURES

- Greater flexibility with installation with spring loaded pin end
- Crown, drive and adaptors available to suit multiple tube sizes
- Smaller Motor end deduction

FUNCTIONAL BENEFITS

- 5V Micro USB Charging
- Antennae Wire Retention Feature
- Levelling control
- Simple limit setting and adjustment
- Favorite position
- 3 operational speed settings
- 2-WAY RF communication
- ARC protocol for simple programming

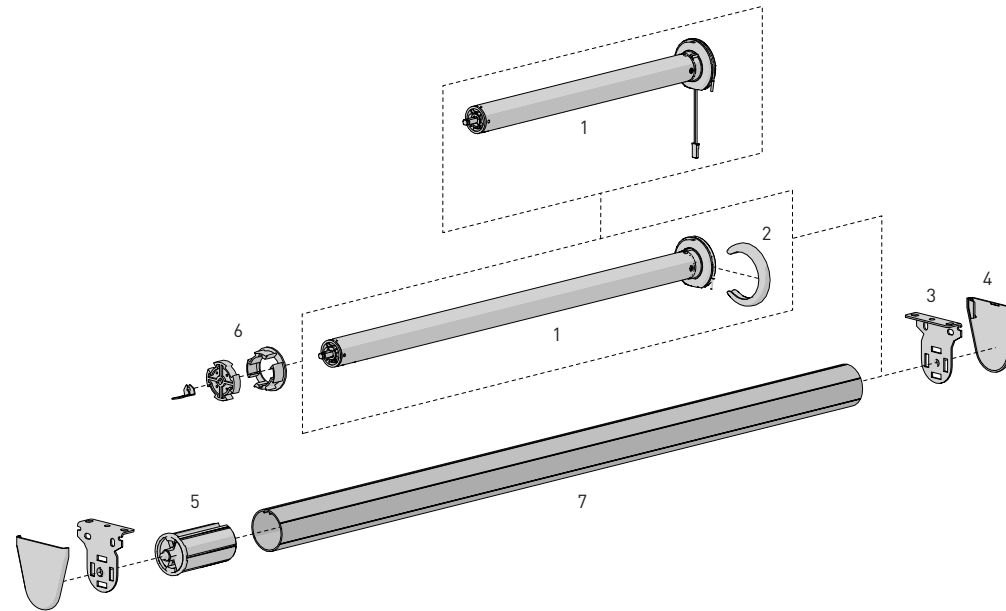

COLOR RANGE



SYSTEM INDEX

- Automate Motor | 25mm
 MT01-1225-069002 - DCRF 1.1Nm 20rpm 12V ZERO
 MT01-1325-069037-CT - Li-ion 0.7Nm 28rpm 5V ZERO CT20
 MT01-1325-069028-CT - Li-ion 0.7Nm 20rpm 5V ZERO CT20
 MT01-1325-069029-CT - Li-ion 1.1Nm 28rpm 5V ZERO CT20

- Motor Cap
 MT03-0502-027001 - Chrome - Li-ion ZERO
 MT03-0502-034001 - Satin Nickel - Li-ion ZERO
 MT03-0502-043001 - Brass - Li-ion ZERO
 MT03-0502-059001 - Black - Li-ion ZERO
 MT03-0502-077001 - White - Li-ion ZERO
 MT03-0502-079001 - Antique Bronze - Li-ion ZERO
 MT03-0502-091001 - Gun Metal - Li-ion ZERO
 MT03-0502-338001 - Gray - Li-ion ZERO
 MTCAP-25-BK - Black - for DCRF
 MTCAP-25-W - White - for DCRF
 MTCAP-25-AB - Antique Bronze - for DCRF
 MTCAP-25-SN - Satin Nickel - for DCRF

- Brackets
 SLB###x - Skyline Bracket
 3 SLNB###x - Skyline Narrow Bracket
 SL01-0306-xxx040 - Skyline LX Bracket - 40mm pitch
 SL01-0306-xxx055 - Skyline LX Bracket - 55mm pitch

- Bracket Covers
 SLBC###x - Skyline Bracket Cover
 4 SLNBC###x - Skyline Narrow Bracket Cover
 RB08-4151-xxx040 - Skyline LX Bracket Cover - 40mm
 RB08-4151-xxx055 - Skyline LX Bracket Cover - 55mm

- Pin End
 5 SLPEV03xx - 1/4" Tube
 SLPEHD53xx - 1/2" Tube

- Crown & Drive Kit
 6 MT03-0109-069003 - 1/4" Tube
 MTCRDR-25-1.5 - 1/2" Tube

- Aluminum Tube
 7 RTEA3T## - 1/4" Tube
 RTEA4T## - 1/2" Tube

= Size | xxx = Color

CONTROL OPTIONS

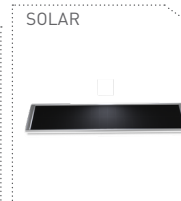
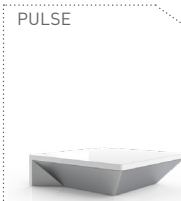

CHARGERS

OPTIONS

UPGRADES

- CASSETTE 80/100/120
- FASCIA 3"/4"/5"
- LINK SYSTEM
- POCKETS 3"/4"/5"/6"

SPECIFICATIONS

DEDUCTION CHART

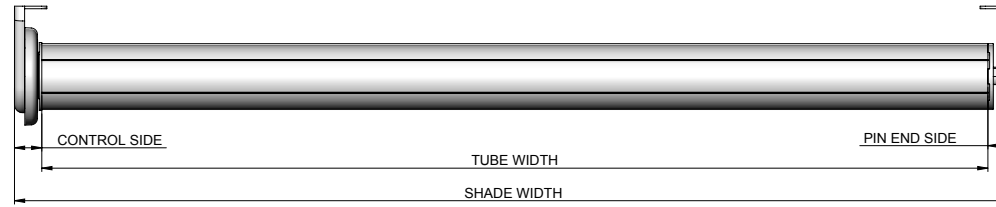

MINIMUM SHADE WIDTH		
TUBE	MOTOR	LENGTH
1 1/4" (using Skyline STD Pin End - SLPEV653xx)	MT01-1225-069002	14-9/16" [370mm]
	MT01-1325-069037-CT	21-9/16" [547mm]
	MT01-1325-069028-CT	21-9/16" [547mm]
	MT01-1325-069029-CT	24-3/8" [619mm]
1 1/2" (using Skyline HD Pin End - SLPEHD53xx)	MT01-1225-069002	16" [406mm]
	MT01-1325-069037-CT	21-9/16" [547mm]
	MT01-1325-069028-CT	21-9/16" [547mm]
	MT01-1325-069029-CT	24-3/8" [619mm]

MOTOR	TUBE	BRACKETS		DEDUCTIONS		
				CONTROL END	PIN END	TOTAL
MT01-1225-069002 MT01-1325-069037-CT MT01-1325-069028-CT MT01-1325-069029-CT	1 1/4"	SKYLINE 1.5"	With Covers	11/16" [17mm]	9/16" [14mm]	1-1/4" [31mm]
			No Covers	9/16" [15mm]	1/2" [13mm]	1-1/8" [28mm]
		SKYLINE LX	With Covers	5/8" [16mm]	9/16" [14mm]	1-3/16" [30mm]
			No Covers	9/16" [15mm]	1/2" [13mm]	1-1/8" [28mm]
	1 1/2"	SKYLINE 1.5"	With Covers	0.67" [17mm]	9/16" [15mm]	1-1/4" [32mm]
			No Covers	9/16" [15mm]	9/16" [14mm]	1-1/8" [29mm]
		SKYLINE LX	With Covers	5/8" [16mm]	9/16" [15mm]	1-1/4" [31mm]
			No Covers	9/16" [15mm]	9/16" [14mm]	1-1/8" [29mm]

MAX ROLL

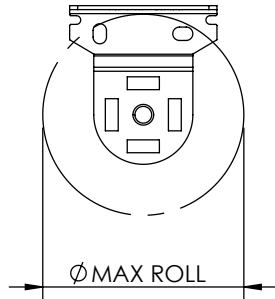

BRACKET/SYSTEM	MAX ROLL SIZE
SLNBxx650xx	2-3/8" [59mm]
SLxx660xx	3" [76mm]
SLxx680xx	4" [102mm]
SL01-0306-xxx040	2-15/16" [74mm]
SL01-0306-xxx055	4-1/16" [103mm]

TUBE SPECS.

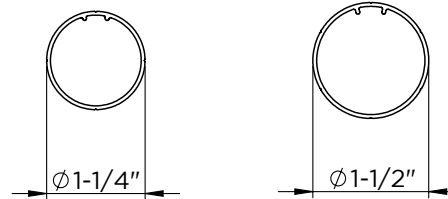

1 1/4" Tube

Code: RTEA3T12 (with tape)

Length 12',16' [3.66m, 4.88m]

1 1/2" Tube

Code: RTEA4T12 (with tape)

RTEA4U12
RTEA4T16 (with tape)
RTEA4U16

Length 12',16'
[3.66m, 4.88m]

MOTORS	MAX LIFTING CAPACITY		MAX DROP*
	1-1/4" TUBE	1-1/2" TUBE	
0.7Nm	9.5lbs [4.3kg]	8.2lbs [3.7kg]	13.1' [4m]
1.1Nm	15.1lbs [6.8kg]	12.8lbs [5.8kg]	13.1' [4m]

* Recommended Max Drop. Exceeding this value may cause fabric tracking issues

SYSTEM CAPACITY

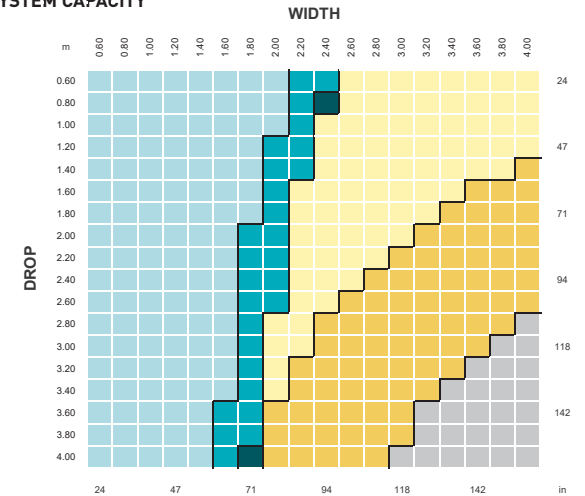

Control	Tube	PARAMETERS
0.7Nm 1.1Nm	1-1/4" 1-1/2"	FABRIC DENSITY: 420gsm
0.7Nm 1.1Nm	1-1/2"	FABRIC THICKNESS: 0.6mm
1.1Nm	1-1/2"	WEIGHT BAR: D30 Medium Bottom Rail
0.7Nm 1.1Nm	Linked	CONTROL: 0.7Nm & 1.1Nm MOTOR
1.1Nm	Linked	
OUTSIDE SPECIFICATIONS		