

S45 AUTOMATE 2.0Nm | 28mm

The motorized 28mm 2.0Nm S45 roller shade system offers multiple tubes to suit a variety of applications. Featuring ARC (Automate Radio Communication), the 28mm 2.0Nm S45 system provides an intelligent Li-ion battery or DC powered solution.

AESTHETICAL FEATURES

- Thinner Motor Head
- Motor cap to color match with brackets

PRODUCTION & ASSEMBLY FEATURES

- Smaller Motor end deduction
- Greater flexibility during installation with spring loaded pin end
- Crown, drive and adaptors available to suit variety of tube sizes

FUNCTIONAL BENEFITS

- 5V Micro USB Charging
- Antennae Wire Retention Feature
- Levelling control
- Simple limit setting and adjustment
- Favorite position
- 3 operational speed settings
- ARC protocol for simple programming
- 2-WAY RF communication

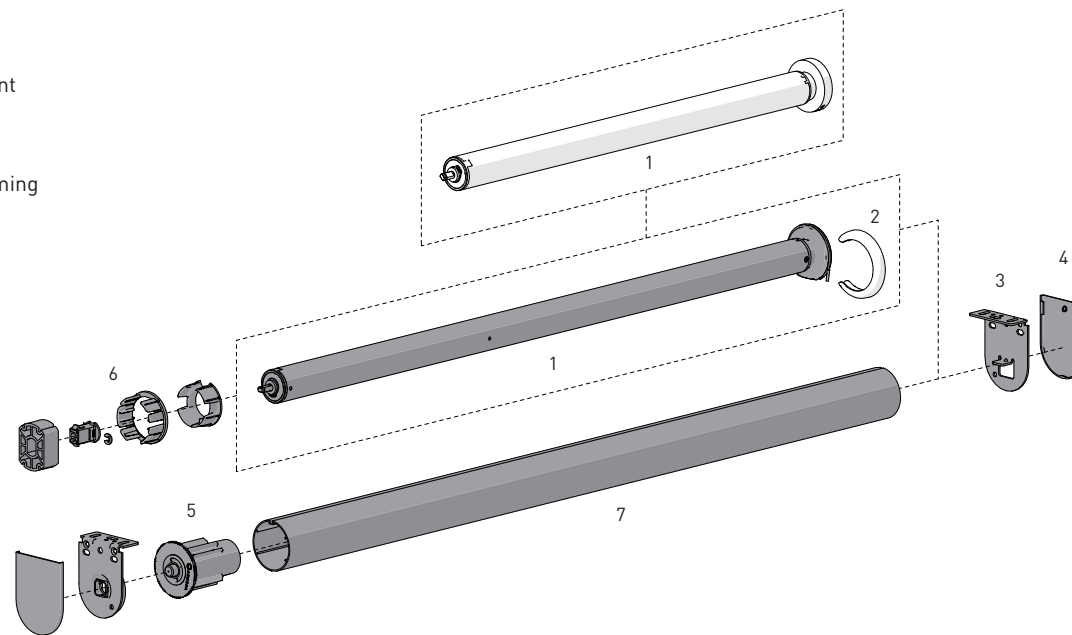

SYSTEM INDEX

1	Automate Motor 28mm MT01-1328-069002 - Li-ion 2.0 ZERO 5V MTDCBRFQ28-2 - Li-ion 2.0 12V MTDCRFQ28-2 - DCRF 2.0 12V
2	Motor Cap MT03-0502-027001 - Chrome - 5V ZERO ONLY MT03-0502-034001 - Satin Nickel - 5V ZERO ONLY MT03-0502-043001 - Brass - 5V ZERO ONLY MT03-0502-059001 - Black - 5V ZERO ONLY MT03-0502-077001 - White - 5V ZERO ONLY MT03-0502-079001 - Antique Bronze 5V ZERO ONLY MT03-0502-091001 - Gun Metal - 5V ZERO ONLY
3	Brackets RB09-0352-xxx0XX
4	Bracket Covers RB08-4152-xxx0XX
5	Pin End RB0-0245-xxx001
6	Crown & Drive Set 28mm MT03-0103-069005
7	S45 T-Spline Aluminum Tubes RB93-X443-000490 - Light RB93-X444-000490 - Standard RB93-X449-000490 - Heavy Duty

- Size
xxx= Color
X = catalogue options

COLOUR RANGE



CONTROL OPTIONS

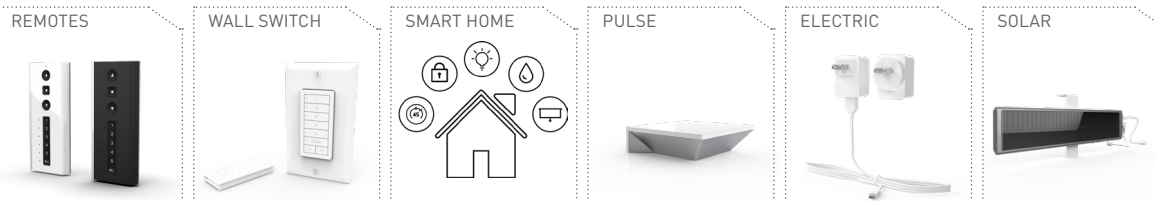

CHARGERS



OPTIONS



SYSTEM UPGRADES

- PELMET 95
- EASY-LINK
- CF90
- MOUNTING RAIL

SPECIFICATIONS

DEDUCTION CHART

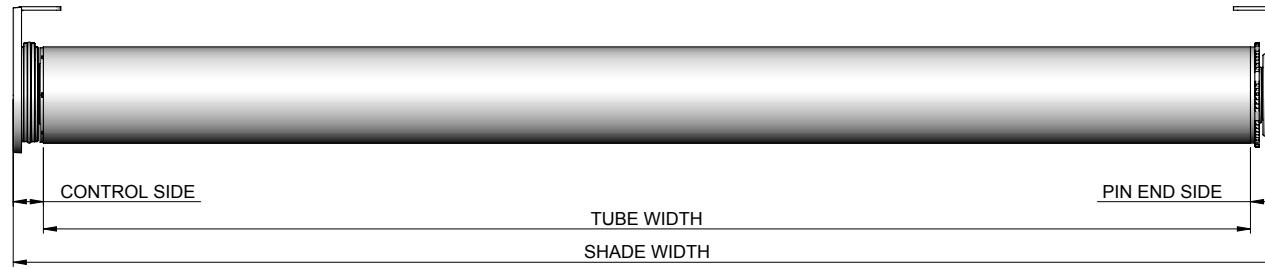

MOTOR	MINIMUM SHADE WIDTH
MT01-1328-069002	2.44' [0.745m]
MTDCRFQ28-2	1.76' [0.535m]
MTDCBRFQ28-2	2.44' [0.745m]

MOTOR	BRACKETS	LIGHT GAP		TUBE DEDUCTION
		CONTROL END	PIN END	
MT01-1328-069002	With Covers	0.55" [14mm]	0.55" [14mm]	1.10" [28mm]
	No Covers	0.51" [13mm]	0.51" [13mm]	1.02" [26mm]
MTDCRFQ28-2 MTDCBRFQ28-2	With Covers	0.63" [16mm]	0.55" [14mm]	1.18" [30mm]
	No Covers	0.60" [15mm]	0.51" [13mm]	1.10" [28mm]

MAX ROLL

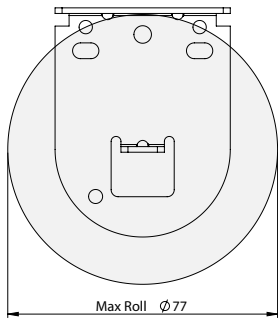

BRACKET	MAX ROLL SIZE
RB09-0352-xxx040	3.03" [77mm]
RB09-0352-xxx050	4.13" [105mm]

TUBE SPECS.

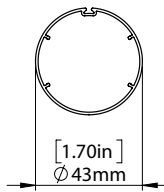

S45 Light Tube

Code RB93-0443-000490
w. tape RB93-6443-000490

Length 16' [4.88m]

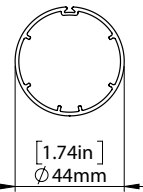

S45 STD Tube

Code RB93-0444-000490
w. tape RB93-6444-000490

Length 16' [4.88m]

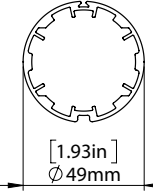

S45 HD Tube

Code RB93-0449-000490
w. tape RB93-6449-000490

Length 16' [4.88m]

MAX LIFTING CAPACITY				MAX DROP**
MOTORS	S45 LT	S45 STD	S45 HD	S45
2.0Nm	20.8lbs [9.4Kg]	20.4lbs [9.2Kg]	18.3lbs [8.3Kg]	13.1' [4.0m]

Exceeding these value may cause fabric tracking issues

SYSTEM CAPACITY

