

## OVERVIEW: PELMET 95 SYSTEM

The Pelmet 95 system is a decorative one piece cover providing an elegant finish, compatible with S40 & S45 Roller Shade systems, Skyline tubes (1-1/4", 1-1/2", 2") and Skyline clutches (SL10 & SL15).

## FEATURES/BENEFITS

- Spring Loaded Installation Brackets; for both top & face fixing/ceiling and wall mounts.
- One piece design, featuring 50mm base bracket mounting allocation.
- Colour coded end caps.
- Fabric-wrap option with spline function.

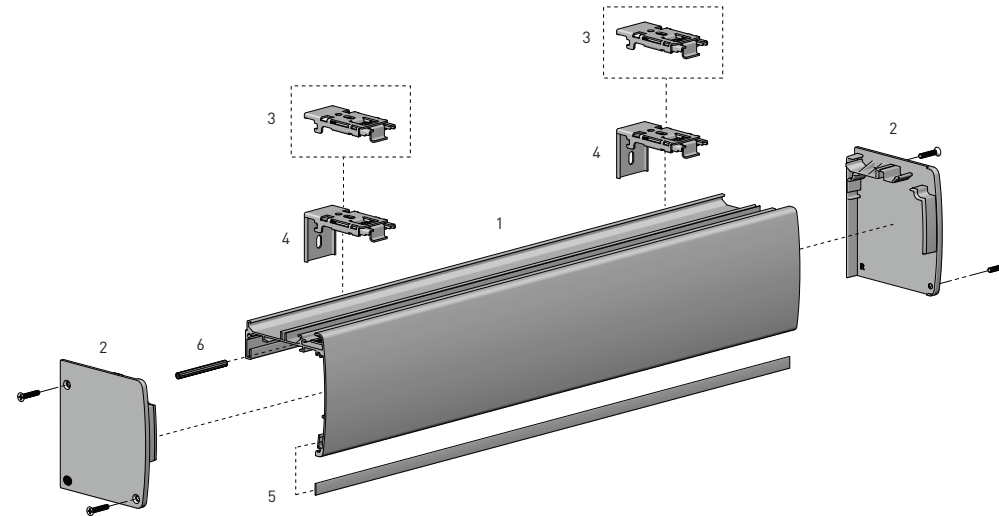





## SYSTEM INDEX

1	PELMET 95 - Base 50 RB88-0150-xxx580
2	PELMET 95 - End Cap Set + Fixing Screws RB88-0101-xxx001
3	PELMET 95 - Spring Loaded Bracket - Top/Ceiling Fix RB88-0121-025001
4	PELMET 95 - Spring Loaded Bracket - Universal Fix RB88-0122-025001
5	9mm Flat Spline RB92-0901-001100 RB92-0902-001075 RB92-0903-001075
6	Ribbed Spline SS91-5246-050300

xxx = colour

## COLOUR RANGE

				
pure white 069	black 050	anodized 020	sandstone 269 [AU ONLY]	silver frost 096 [AU ONLY]

## COMPATIBLE SYSTEMS

Chain Control S40 (AU only) / S45 / Skyline

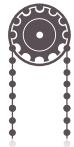

Crank Gear S45



Motorised S45



AERO Single and ESU/ESW

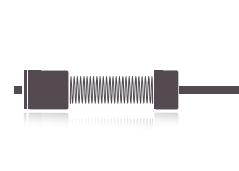

Easy-Link

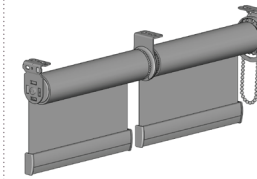

SPECIFICATIONS: PELMET 95 SYSTEM

MAX ROLL

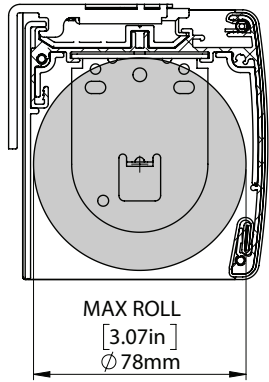

DEDUCTIONS

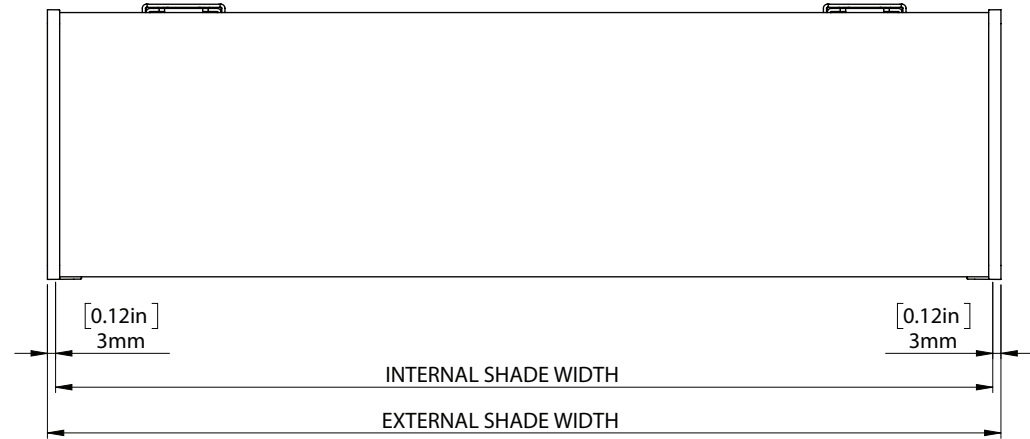

DIMENSIONS

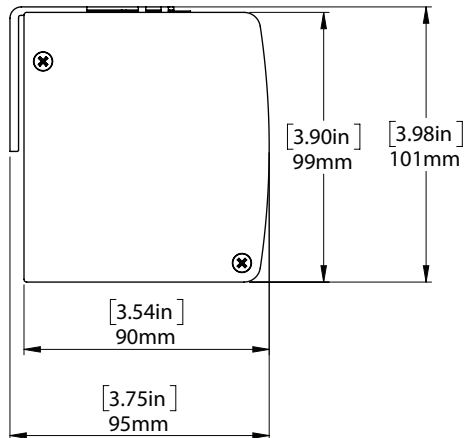

PELMET 95 WITH FABRIC ATTACHED

