

OUTDOOR SHADES

SECTION 1	CORE HARDWARE	
	Box Cassettes	96
	Open Brackets	98
	Controls	99
	Tubes	100
	Weight Bars	104
SECTION 2	SIDE GUIDE OPTIONS	
	Zipscreen	106
	Pivot Arm	107
	Wire Guide	107

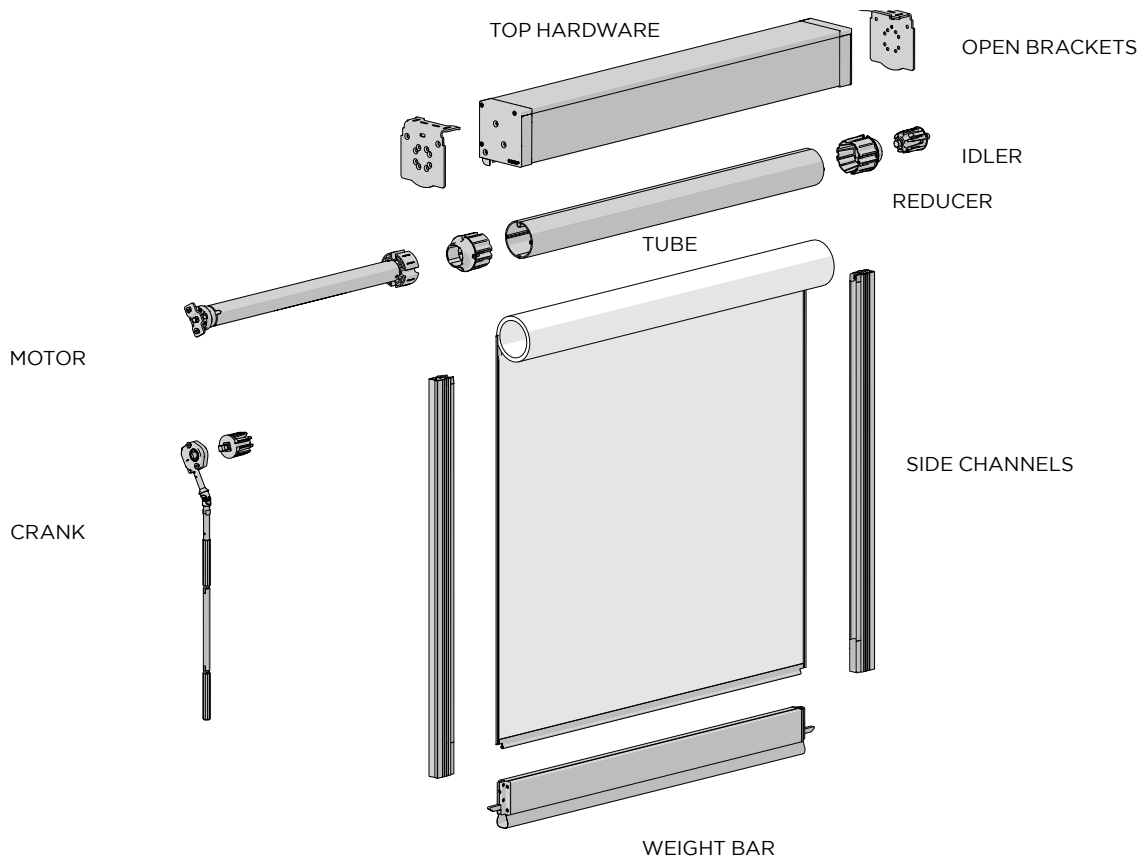

COLOR RANGE

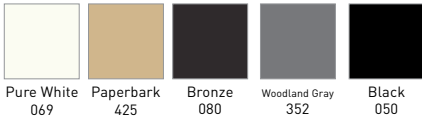

SYSTEM OPTIONS

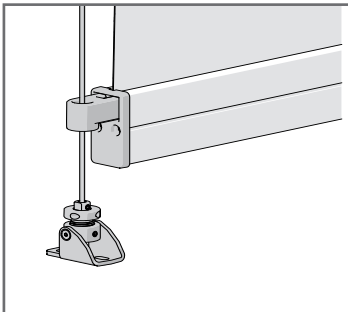

WIRE GUIDE

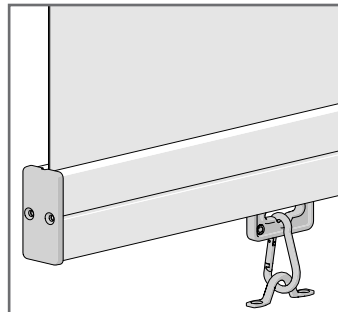

STRAIGHT DROP

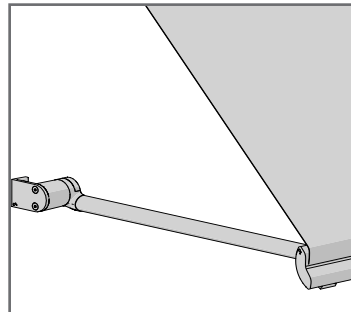

PIVOT ARM

System	Top Hardware			Tubes				Controls		W.Bars		
	Box 120	Box 190	Open	78mm	110mm	130mm	160mm	Crank	Motor	F56	F72	Pivot
Zipscreen	✓	✓	✓	✓	✓	✓		✓	✓	✓	✓	
Wire Guide	✓	✓	✓	✓	✓	✓	✓	✓	✓	✓	✓	
Straight Drop	✓	✓	✓	✓	✓	✓		✓	✓	✓	✓	
Pivot Arm	✓		✓	✓				✓	✓			✓

CASSETTE BOX 120

BOX 120 BACK

Colors include protective film | 19ft (5.8m) piece

TYPE	Mill (000)	Colors - refer below
PRICE		
CODE	RE01-0101-000580	RE01-0101-xxx580-PF
PACK	1	1



COLOR. Refer to color range on system overview page
 USE WITH. Box 120 Covers & Box 120 End Plate Set

BOX 120 FULL COVER

Colors include protective film | 19ft (5.8m) Piece

TYPE	Mill (000)	Colors - refer below
PRICE		
CODE	RE01-0102-000580	RE01-0102-xxx580-PF
PACK	2	2



COLOR. Refer to color range on system overview page
 USE WITH. Box 120 Back, Box 120 End Plate Set

BOX 120 FASCIA COVER

Colors include protective film | 19ft (5.8m) piece

TYPE	Mill (000)	Colors - refer below
PRICE		
CODE	RE01-0103-000580	RE01-0103-xxx580-PF
PACK	4	4



COLOR. Refer to color range on system overview page
 USE WITH. Box 120 Back, Box 120 End Plate Set

BOX 120 END PLATE SET

LH & RH

TYPE	Mill (000)	Colors - refer below
PRICE		
CODE	RE01-1101-000120	RE01-1101-050120
PACK	2	2

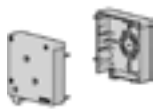

COLOR. Refer to color range on system overview page
 USE WITH. Box 120 Back, Box 120 Full Cover, Box 120 Fascia

CASSETTE BOX 190

BOX 190 UNIVERSAL EXTRUSION

Colors include protective film | 22.9ft (17m)

TYPE	Mill (000)	Colors - refer below
PRICE		
CODE	RE01-0106-000700	RE01-0106-xxx700-PF
PACK	1	1



COLOR. Mill (000), Black (050), Pure White (069)
 USE WITH. Box 190 Front Cover, Box 190 Two-Side End Plate Set

BOX 190 - UNIV. BRACKET EXTRUSION X4" (100MM) ANOD

PRICE	
CODE	RE01-1105-020100
PACK	2



COLOR. Anodized (020)
 USE WITH. Box 190 Universal Extrusion

BOX 190 - FRONT COVER X 22.9 FT (7M) LENGTH MILL

Colors include protective film | 22.9ft (17m)

TYPE	Mill (000)	Colors - refer below
PRICE		
CODE	RE01-0107-000700	RE01-0107-050700-PF
PACK	1	1



COLOR. Mill (000), Black (050), Pure White (069)
 USE WITH. Box 190 Universal Extrusion, Box 190 Two-Side End Plate Set

BOX 190 TWO-SIDE END PLATE SET

TYPE	Mill (000)	Colors - refer below
PRICE		
CODE	RE01-1105-000000	RE01-1105-xxx001
PACK	1	1

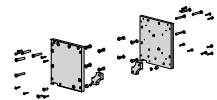

COLOR. Mill (000), Black (050), Pure White (069)
 USE WITH. Box 190 Universal Extrusion & Bracket, Extreme Bracket adapters, Wire Guide adapter plate

FOAM TAPE

TYPE	0.063" x 0.354"
PRICE	
CODE	SB91-0516-050009
PACK	45



COLOR. Black (050)
 USE WITH. Box 190 Universal Extrusion, Box 190 Front Cover

FABRIC BRUSH T SLOT FIT

10m x 4.8mm | 200m Roll

PRICE	
CODE	SB91-0012-050300
PACK	200



COLOR. Black (050)
 USE WITH. Box 190 Front Cover, Universal Bracket Extrusion

OPEN BRACKETS | SQUARE | 78MM

TYPE	Stainless Steel [012]	Colors - refer below
PRICE		
CODE	RE01-3031-012000	RE01-3030-025000
PACK	2	2



COLOR. Refer to color range on system overview page - Silver Zinc Plated [025] also available

OPEN BLIND EXTERNAL BRACKETS - S/S 304 | NATURAL EXTERNAL BRACKETS | ROUND | 78MM

TYPE	Stainless Steel	Color - refer below
PRICE		
CODE	RE01-3021-012000	RE01-3020-025000
PACK	2	2



COLOR. Refer to color range on system overview page - Silver Zinc Plated [025] also available

ZIPSCREEN EXTREME | BRACKET KIT

Universal + Screws

TYPE	Polished SS
PRICE	
CODE	SB03-1301-009190
PACK	1

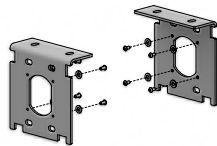

COLOR. Polished Stainless Steel [009]
USE WITH. Extreme Square Bracket Plates

EXTREME OUTSIDE/WALL MOUNT BRACKET SET | S100

& adapter

PRICE	
CODE	RB80-1201-xxx109
PACK	1



COLOR. Pure White [069], Black [050]
USE WITH. Zamak Adapter, Extreme Bearing Idler

INSIDE MOUNT BRACKET KIT | MOTOR | S100

PRICE	
CODE	RB80-0478-069100
PACK	1

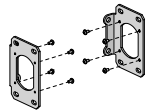

COLOR. Pure White [069]
USE WITH. Extreme Bracket Adapter Kit

CONTROL

CRANKS

78MM TUBES

CRANK OPERATION GEAR - RATIO 5:1

with fixing screws

TYPE	Mill (000)	Color
PRICE		
CODE	RE01-0513-000003	RE01-0513-050003
PACK	5	5



COLOR. Mill (000), Black (050)

USE WITH. Crank Housing, Box 120 End Plate Set, Open Blind Brackets

CRANK OPERATION GEAR- RATIO 8:1

with fixing screws

TYPE	Mill	Color
PRICE		
CODE	RE01-0517-000003	RE01-0517-050003
PACK	5	5



COLOR. Mill (000), Black (050)

USE WITH. Crank Housing, Box 120 End Plates, Open Blind Brackets

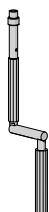
GEAR/CRANK OPERATION CONTROL ARM

SIZE	3.2ft (100cm)	4.9ft (150cm)	6.5ft (200cm)
PRICE			
CODE	RB05-9101-340100	RB05-9101-340150	RB05-9101-340200
PACK	5	5	5

COLOR. Gray (340)

USE WITH. Crank Operation Gear, Gear/Crank Operation Arm Support

GEAR/CRANK OPERATION ARM SUPPORT

PRICE	
CODE	RB05-9102-xxx000
PACK	5



COLOR. Pure White (069), Gray (340)

USE WITH. Gear/Crank Operation Control Arm

CRANK ADAPTOR | 45MM

PRICE	
CODE	RE01-0502-050045
PACK	5

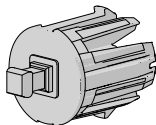

COLOR. Black (050)

USE WITH. Crank Operation Gear, 45mm reducer, 45mm to 78mm Crown

RE01 GEAR | UNIVERSAL JOINT

PRICE	
CODE	RE01-0510-020000
PACK	10

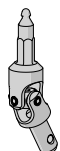

COLOR. Anodised

USE WITH. Crank Operation Gear, Crank Operation Control Arm

CONTROL **MOTORS** 78MM TUBES

AUTOMATE VEUE 45MM SLIM MOTOR 10MM SQ. SHAFT

TYPE	45mm
PRICE	
CODE	RE01-0603-025000
PACK	1



COLOR. Silver Zinc Plated [025]
USE WITH. Automate Bracket Adapter

AUTOMATE | 78MM DRIVE WHEEL | STD MOTOR
WHILE SUPPLIES LAST

TYPE	78mm
PRICE	
CODE	RE01-0679-050508
PACK	5

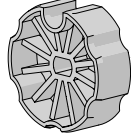

AUTOMATE VEUE 45MM MOTOR BRACKET ADAPTER
+ screws

TYPE	45mm
PRICE	
CODE	RE01-0601-025000
PACK	5



COLOR. Silver Zinc Plated [025]
USE WITH. Automate 10mm Sq. Shaft

AUTOMATE | 78MM DRIVE SINGLE PIECE (NEW)

PRICE	
CODE	MT03-0106-050006
PACK	5



COLOR. Black [050]
USE WITH. Automate FT Motor, 78mm Aluminum Tube

AUTOMATE | 78MM DRIVE WHEEL | IMPACT DETECT
WHILE SUPPLIES LAST

TYPE	78mm
PRICE	
CODE	RE01-0680-050518
PACK	5



COLOR. Black [050]
USE WITH. Automate FT Motor, 78mm Tube

AUTOMATE REMOTES



TYPE	Push 15	Push 5	1 Channel
PRICE			
CODE	MT02-0101-067008	MT02-0101-067004	MTRF-REM-1C
PACK	1	1	1

TYPE	15 Channel
PRICE	
CODE	MTRF-REM-15NL
PACK	1

COLOR. White

AUTOMATE | 63MM DRIVE WHEEL | IMPACT DETECT

TYPE	63mm
PRICE	
CODE	RE01-0666-050518
PACK	5



COLOR. Black [050]
USE WITH. Automate FT Motor, 63mm Tube

MOTOR DRIVE CLIP FOR 35/45MM MOTORS

TYPE	35/45mm
PRICE	
CODE	MTCLIP-35-45
PACK	100



AUTOMATE | CROWN WHEEL - 63MM UNIVERSAL

TYPE	63 mm
PRICE	
CODE	RE01-0663-050518
PACK	5



COLOR. Black [050]
USE WITH. Automate FT Motor, 63mm Tube

15NM FT ACRF MOTOR [Ø45/110V/32RPM] 10' CORD PLUG

TYPE	45mm/15Nm/32r Quiet
PRICE	
CODE	MT01-1145-069003
PACK	1



COLOR. Pure White [069]
USE WITH. 78mm Alu/Steel tubes, 78mm Automate Drive & Crown Wheel

CONTROL

MOTORS

110/130MM TUBES

EXTREME CROWN WHEEL | S100

PRICE	
CODE	RB80-0701-073100
PACK	1

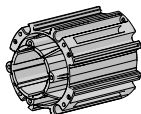

COLOR. Gray Cloud (073)
 USE WITH. AX Motors, Aluminum Tube S100-100STD & 130HD

EXTREME DRIVE WHEEL | S100

PRICE	
CODE	RB80-0301-073100
PACK	1



COLOR. Gray Cloud (073)
 USE WITH. Drive Wheel Adaptor, Aluminum Tube S100-100STD & 130HD

AUTOMATE | AX MOTOR DRIVE ADAPTOR KIT

PRICE	
CODE	MT03-0198-025008
PACK	1



COLOR. Silver Zinc Plated (025)
 USE WITH. AX Motor, Extreme Drive Wheel

AUTOMATE | AX30 ARC MOTOR [Ø45/110V/12RPM] LC

PRICE	
CODE	MT01-1145-069018
PACK	1



COLOR. Pure White (069)
 USE WITH. Extreme Crown & Drive, Drive Wheel Adaptor

AX50 ARC MOTOR [Ø45/110V/13RPM] 20' CORD PLUG

PRICE	
CODE	MT01-1145-069017
PACK	1



COLOR. Pure White (069)
 USE WITH. Extreme Crown & Drive, Drive Wheel Adaptor

TUBES 78MM **EXT**

78MM HD TUBE W/ SCREW FEATURES
19ft (5.8m) Piece

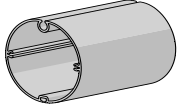

TYPE	STD-5.8m	HD-5.8m
PRICE		
CODE	RE01-0377-000580	RE01-0380-000580
PACK	2	2

COLOR. Mill (000)
USE WITH. 78/45mm Reducer, 78/45mm Crown, #6 Zip,

STEEL TUBE 78MM
22.9ft (7m) Piece



PRICE	
CODE	AW92-0901-000700
PACK	1

COLOR. Mill (000)
USE WITH. Zipscreen Reducer

BEARING IDLER | 45MM

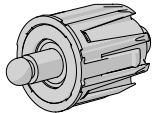

PRICE	
CODE	RE01-0213-050045
PACK	510

COLOR. Black (050)
USE WITH. 45mm Reducer, 45mm Crown

ZIPSCREEN REDUCER 78 | 45MM W/ SCREW

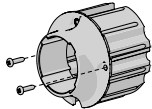

PRICE	
CODE	RE20-0311-050178
PACK	4

COLOR. Black (050) only
USE WITH. 78mm tube, 45mm Bearing Idler, 45mm Crank Adaptor, 45mm Motors

AUTOMATE | 78MM CROWN (NEW)

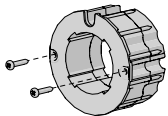

PRICE	
CODE	MT03-0106-050005
PACK	5

COLOR. Black (050)
USE WITH. 78mm tube, 45mm Bearing Idler, 45mm Crank Adaptor, 45mm Motors

ALUMINUM TUBE 63MM
19ft (5.8m) Piece



PRICE	
CODE	RE01-0363-000580
PACK	4

COLOR. Mill (000)
USE WITH. Bearing Idler, Idler Housing, Crank Housing 63mm, Automate Motor

IDLER ADAPTER MKII | RETAINER CLIP + SCREW



PRICE	
CODE	RE01-0214-050000
PACK	5

COLOR. Black (050)
USE WITH. Idler, Standard Idler, Box 120 End Plate, Open Blind Brackets

ALUMINUM STD TUBE 78MM
19ft (5.8m) Piece ****WHILE SUPPLIES LAST****



PRICE	
CODE	RE01-0378-000580
PACK	2

COLOR. Mill (000)
USE WITH. Zipscreen Reducer

ALUMINUM HD TUBE 78MM
22.9ft (7m) Piece ****WHILE SUPPLIES LAST****



PRICE	
CODE	RE01-0379-000700
PACK	2

COLOR. Mill (000)
USE WITH. Zipscreen Reducer

BEARING IDLER | 63MM



PRICE	
CODE	RE01-0203-050063
PACK	10

COLOR. Black (050)
USE WITH. 63mm Tube, Idler Bracket Adapter

TUBES S100

TUBES/WEIGHT BAR **FABRIC ATTACHMENT**

EXTREME BEARING IDLER | S100



PRICE	
CODE	RB80-0202-073100
PACK	1

COLOR. Gray Cloud [073]
USE WITH. Extreme Bracket Set or Plate, Aluminum Tube S100-100STD & 130HD

ZIP | NO.6 GAUGE
Double Sided - 1 Roll = 656ft (200m)



PRICE	
CODE	SH91-0135-050200
PACK	200

COLOR. Black [050]
USE WITH. Fabric, Zip Inner Rail

ALUMINUM TUBE | S100 - 110 STANDARD
O.D 4.33" x 22.9ft (110mm x 7m) piece / No Tape



PRICE	
CODE	RB93-0110-000600
PACK	2

COLOR. Mill [000]
USE WITH. Extreme Crown & Drive, Reducer Set, Tail Spline

7MM FABRIC SPLINE WITH 15MM TAIL
328ft (100m) roll



PRICE	
CODE	SB91-0409-050015
PACK	1

COLOR. Black [050]
USE WITH. F56 Weight Bar, F72 HD Weight Bar, 78mm tubes

ALUMINUM TUBE | S100 - 130 HEAVY DUTY
O.D 5.12" x 22.9ft (130mm x 7m)

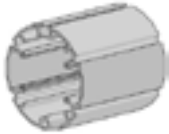

TYPE	22.9ft (7m)
PRICE	
CODE	RB93-0130-000700
PACK	1

COLOR. Mill [000]
USE WITH. Extreme Crown & Drive, Reducer Set, Tail Spline

7.2MM SPLINE WITH 15MM TAIL
328ft (100m) roll



PRICE	
CODE	SB91-0408-001015
PACK	1

COLOR. Clear [001]
USE WITH. F56 Weight bar, 78mm Steel & Alu. Tube

ZIPSCREEN EXTREME REDUCER SET
2 piece set + screws



PRICE		
CODE	RB80-0501-050110	RB80-0501-050130
PACK	2	2

COLOR. Black [050]
USE WITH. S100 Aluminum tube, S130 Aluminum tube

EXTREME SQUARE MOTOR BRACKET PLATE | S100
4.33" x 0.197" (110mm x 5mm) - Inside Mount



PRICE	
CODE	RB80-1503-xxx110
PACK	1

COLOR. Pure White [069], Black [050]
USE WITH. End Plates, Motor Adaptor

ALUMINUM TUBE | S100 - 160 EXTRA HEAVY DUTY
O.D. 6.3" x 22.9ft (160mm x 7m)

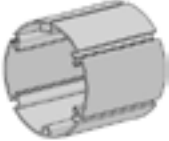

TYPE	22.9ft (7m)
PRICE	
CODE	RB93-0160-000700
PACK	1

COLOR. Mill [000]
USE WITH. S100 - 130 Tube, Tail Spline

EXTREME TUBE END PLATE | S100
2 Piece Set + screws



TYPE	110 Standard	130 Heavy Duty	160 Extra Heavy Duty
PRICE			
CODE	RB80-0601-073110	RB80-0601-073130	RB80-0601-073160
PACK	1	1	1

COLOR. Gray Cloud [073]
USE WITH. S100 Aluminum Tube- 110mm, 130mm & 160mm

F56 WEIGHT BAR PLAIN END CAP

PRICE	
CODE	RE15-0501-050000
PACK	5

COLOR. Black (050)
USE WITH. F56 Weight Bar



F56 WEIGHT BAR

Colors include protective film | 19ft (5.8m) Piece

SIZE	Mill (000)	Colors - refer below
PRICE		
CODE	RE15-0101-000580	RE15-0101-xxx580-PF
PACK	2	2

COLOR. Refer to color range on system overview page
USE WITH. F56 Weight Bar Plain End Cap, 7.2mm Tail Spline



F72 PLAIN END CAP SET + SCREWS

PRICE	
CODE	RE15-0540-050000
PACK	5

COLOR. Black (050)
USE WITH. F72 HD Weight Bar



F72 MULTI-BAR END CAPS | WIRE GUIDE + SCREWS

PRICE	
CODE	RE15-0522-xxx000
PACK	5

COLOR. Black (050), Pure White (069)
USE WITH. F72 HD Weight Bar



WIRE GUIDE HEM BAR END CAPS

Includes Screws

PRICE	
CODE	RE15-0601-050001
PACK	5

COLOR. Black (050), Pure White (069)
USE WITH. F56 Weight Bar



F56 LOCK END CAP SET

PRICE	
CODE	RE20-0303-050002
PACK	10

COLOR. Black (050), Pure White (069)
USE WITH. F56 Weight Bar, Ultra Lock V2



F72 MULTI-BAR END CAP

PRICE	
CODE	RE15-0512-050000
PACK	5

COLOR. Black (050)
USE WITH. F72 HD Weight Bar, Ultra-Lock V2

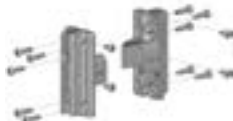

F72 HD EXTERNAL WEIGHT BAR

Colors include protective film | 19ft (5.8m) Piece

TYPE	Mill (000)	Colors - refer below
PRICE		
CODE	RE15-0112-000700	RE15-0112-xxx700-PF
PACK	1	1

COLOR. Refer to color range on system overview page
USE WITH. F72 End Caps, Ultra Lock V2, Flat Ballast, 7mm Fabric Spline, 15mm PVC Spline



FLAT BALLAST BAR

0.79" x 0.20" x 9.8ft Length

PRICE	
CODE	SB91-1005-033300
PACK	10

COLOR. Galvanized (033)
USE WITH. F56 Weight Bar



25MM STRAIGHT DROP LOOP

PRICE	
CODE	RE91-1102-050025
PACK	10

COLOR. Black (050)
USE WITH. F56 weight bar



FLAT BALLAST BAR - WRAPPED

0.98" x 0.31" x 6.6ft Length

PRICE	
CODE	SB91-1018-050200
PACK	5

COLOR. Black (050)
USE WITH. F72 HD Weight Bar



STRAIGHT DROP PAD EYE SADDLE - 30MM

PRICE	
CODE	RE91-1104-013030
PACK	10

COLOR. Polished Stainless Steel (013)
USE WITH. Straight Drop Spring Clip - 50mm



25MM CAM BUCKLE & STRAP ASSEMBLY

PRICE	
CODE	RE91-0100-025025
PACK	2

COLOR. Silver Zinc Plated (025)
USE WITH. 25mm straight drop loop, 28mm footmans loop

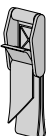

WEIGHT BAR BUBBLE SEAL PUSH FIT

TYPE	429ft (150m)
PRICE	
CODE	SB91-0013-050150
PACK	150

COLOR. Black (050)
USE WITH. F56 Weight Bar, F72 HD Weight Bar



25MM FOOTMANS LOOP

PRICE	
CODE	RE91-1101-013025
PACK	10

COLOR. Stainless Steel (013)
USE WITH. 25mm strap down loop



BUBBLE SEAL STRIP

19ft (5.8m) piece

PRICE	
CODE	SB91-0001-050580
PACK	10

COLOR. Black (050)
USE WITH. F56 Weight bar, Zipscreen Weight Bar Latch



STRAIGHT DROP SPRING CLIP - 50MM

PRICE	
CODE	RE91-1103-009050
PACK	10

COLOR. Stainless Steel (009)
USE WITH. 25mm straight drop loop & pad eye saddle



ZIPSCREEN WEIGHT BAR LATCH

+ Screws

PRICE	
CODE	SB07-2103-050001
PACK	10

COLOR. Black (050)
USE WITH. Weight Bar, U Mounting Rail



F72 FOOTMANS LOOP KIT

PRICE	
CODE	RE91-1111-013025
PACK	5

COLOR. Stainless Steel (013)
USE WITH. F72 HD Weight Bar



16MM BUBBLE SEAL | F72

PRICE	
CODE	SB91-0018-050040
PACK	40

COLOR. Black (050)
USE WITH. F72 HD Weight Bar



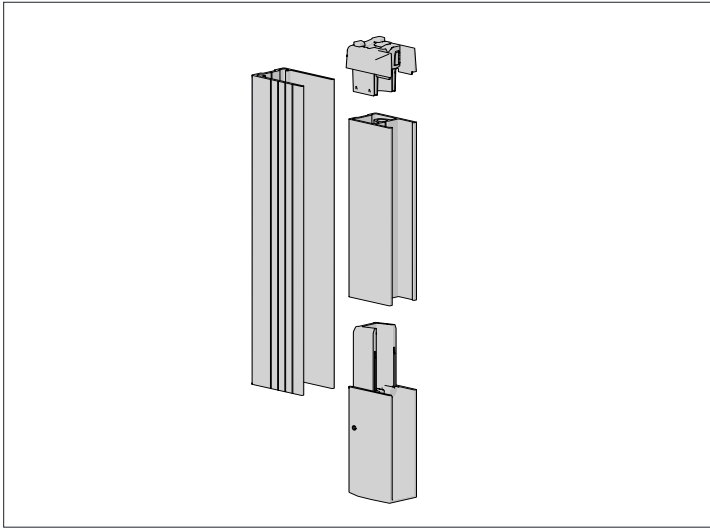

ZIP - L FIXING RAIL | BOX 160/190 | 5.5M-MILL

COMING SOON

TYPE	Mill (000)	Colors - refer below
PRICE		
CODE	SB04-0708-000550	SB04-0708-050550-PF
PACK	8	8

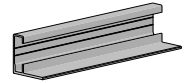

COLOR. Black (050), Pure White (069)
 USE WITH. Box 190, Extreme Open Brackets

ZIPSCREEN | U MOUNTING RAIL



SIZE	18ft (5.5m)	18ft (5.5m) piece
TYPE	Mill (000)	Colors - refer below
PRICE		
CODE	SB04-0702-000550	SB04-0702-050550-PF
PACK	10	10

COLOR. Black (050), Pure White (069), Bronze (080)
 USE WITH. Zip Inner Rail, L Fixing Rail, End Plate set

ZIPSCREEN - FUNNEL W/ INTEGRATED TOP STOP + SCREW

PRICE	
CODE	SB05-1412-050001
PACK	50

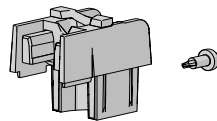

COLOR. Black (050)
 USE WITH. Zip Inner Rail

ZIPSCREEN | ZIP INNER RAIL



SIZE	18ft (5.5m) piece	18ft (5.5m) piece
TYPE	Mill (000)	Colors - refer below
PRICE		
CODE	SB04-0701-000550	SB04-0701-xxx550
PACK	10	10

COLOR. Refer to color range on system overview page
 USE WITH. U Mounting Rail, Inner Rail Funnel & Stop Set, Inner Rail Bottom Cap Set

ZIPSCREEN | FACE FIX - U MOUNTING RAIL

18ft (5.5m) Meter length

PRICE	
CODE	SB04-0705-000550
PACK	8



COLOR. Mill (000)
 USE WITH. Zip Inner Rail, End Plate set

ZIPSCREEN | L FIXING RAIL

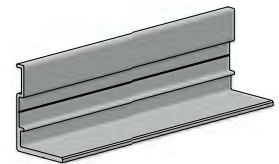

SIZE	8.2ft (2.5m) piece	18ft (5.5m) piece	18ft (5.5m) piece
TYPE	Mill (000)	Mill (000)	Color - refer below
PRICE			
CODE	SB04-0703-000250	SB04-0703-000550	SB04-0703-xxx550
PACK	10	10	10

COLOR. Refer to color range on system overview page
 USE WITH. U Mounting Rail

ZIPSCREEN | ZIP INNER RAIL BOTTOM CAP SET

+ Screw

PRICE	
CODE	SB05-1511-050001
PACK	10

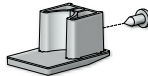

COLOR. Black (050)
 USE WITH. Zip Inner Rail

ULTRA LOCK V2

Kit Assembly (Pin & Latch only)

PRICE	
CODE	RE15-0422-050001
PACK	5



COLOR. Black (050)
 USE WITH. Weight Bars, Inner Rail

PIVOT ARM

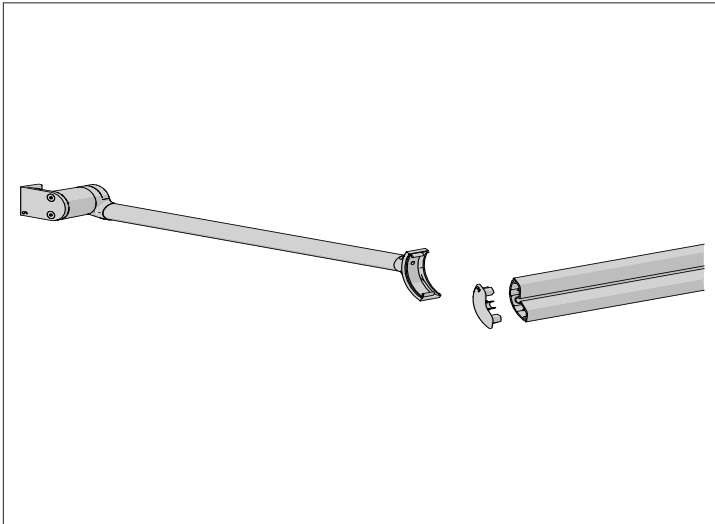

WIRE GUIDE 3.2MM **EXT**



PIVOT ARM TERMINAL BAR
16.4ft (5m) Piece

PRICE	
CODE	RE29-0102-xxx500
PACK	1



COLOR. Pure White (069), Black (050)
USE WITH. Pivot Arms and cover caps

DOME HEAD TERMINAL
For 3.2mm Wire



PRICE	
CODE	RE24-1312-009002
PACK	20

COLOR. Polished Stainless Steel (009)
USE WITH. 3.2mm Wire Tensioning Guide

PIVOT ARMS
1 Set = 2 Arms

TYPE	5.25ft (1.6m)
PRICE	
CODE	AW05-0701-069160
PACK	0



COLOR. Black (050), Pure White (069)
USE WITH. Pivot Arm Terminal Bar

WIRE TENSIONING GUIDE - 3.2MM
Thread: 1 x 19 | 1 Roll = 164ft (50m)



PRICE	
CODE	RB91-3602-010032
PACK	1

COLOR. Stainless Steel (010)
USE WITH. Dome Head Terminal

PIVOT ARM COVER CAP FOR TERMINAL BAR



PRICE	
CODE	AW05-0801-xxx000
PACK	1

COLOR. Pure White (069), Black (050)
USE WITH. Pivot Arm Terminal Bar

BOTTOM WIRE GUIDE SWIVEL BRACKET
Floor/Wall Mount



PRICE	
CODE	RE24-2205-009000
PACK	4

COLOR. Polished Stainless Steel (009)
USE WITH. Swaged Dome Stud Terminal, 3.2mm Wire

WIRE CABLE - TOP BRACKET + SCREW

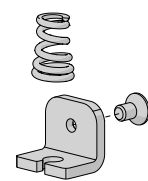

PRICE	
CODE	RE24-4002-010032
PACK	4

COLOR. Stainless Steel (010)
USE WITH. Open Brackets

SWAGED DOME STUD TERMINAL
13.7ft (4.2m) Wire



PRICE	
CODE	RE24-1312-009420
PACK	4

COLOR. Polished Stainless Steel (009)
USE WITH. Wire Guide Top Saddle Terminal Kit w/ Springs

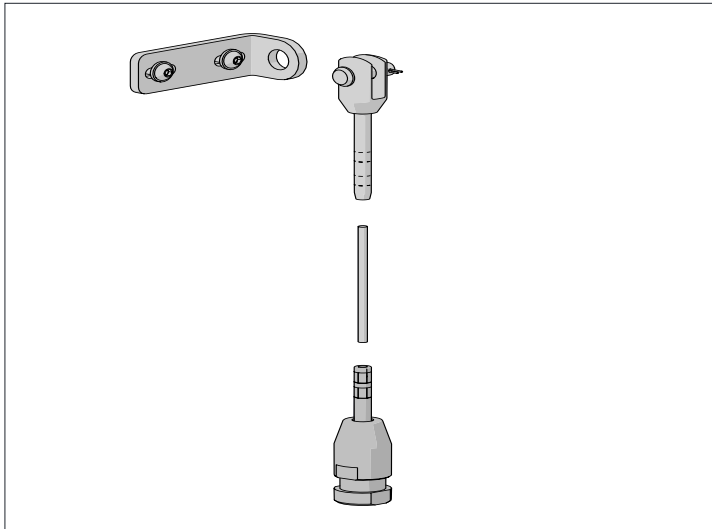

WALL MOUNTING L BRACKET - LH AND RH SET

3.54" x 1.5" (90mm x 38mm)

PRICE	
CODE	RE24-2301-009090
PACK	1

COLOR. Polished Stainless Steel (009)
USE WITH. Threaded Stud Terminal

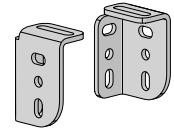

THREADED STUD TERMINAL

+ nut & washer

PRICE	
CODE	RE24-1401-009040
PACK	2

COLOR. Polished Stainless Steel (009)
USE WITH. Swage Fork Terminal



ZAMAK ADAPTER SPACER

PRICE	
CODE	RB80-0411-025050
PACK	1

COLOR. Zinc Plated (025)
USE WITH. Zamak Adapter

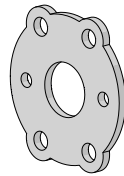

TENSION SPRING

14.5 I.D. x 23.5 O.D x 50mm

PRICE	
CODE	RE24-9101-009050
PACK	2

COLOR. Polished Stainless Steel (009)
USE WITH. Threaded Stud Terminal



MOTOR EXTREME WIRE GUIDE BRACKET ADAPTER KIT

Outside / Wall Mount

TYPE	Zinc Plated	Colors - refer below
PRICE		
CODE	RB80-0476-025100	RB80-0476-xxx100
PACK	1	1

COLOR. Black (050), Pure White (069)
USE WITH. Extreme Bracket Set - Outside/Wall Mount

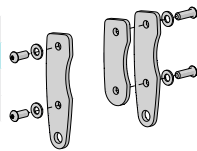

BOX 190 WIRE GUIDE ADAPTER PLATE

PRICE	
CODE	RB80-0481-012000
PACK	2

COLOR. Stainless Steel (012)
USE WITH. Box 190 end plates and fork terminal



SWAGE FORK TERMINAL

0.16" (4mm) stainless steel wire

PRICE	
CODE	RE24-1314-009400
PACK	2

COLOR. Polished Stainless Steel (009)
USE WITH. Extreme Bracket Set - Outside/Wall Mount, Wire Guide Cable



WIRE GUIDE TENSIONING CABLE 4MM

164ft (50m) Roll

PRICE	
CODE	RB91-3602-006040
PACK	1

COLOR. Stainless Steel (006)
USE WITH. Flat Head Stud & Swage Fork Terminals, F72 HD Weight Bar End Cap



TENSIONING BRACKET & FLAT HEAD STUD TERMINAL

0.16" (4mm) stainless steel wire

PRICE	
CODE	RE24-2601-009040
PACK	2

COLOR. Polished Stainless Steel (009)
USE WITH. 4mm Wire Guide Cable



OPTIONAL ACCESSORIES

EXT

AUTOMATE | SOLAR WIND/ LIGHT SENSOR

TYPE	SOLAR POWERED
PRICE	
CODE	MT02-0301-072001
PACK	1

COLOR. White (072)
USE WITH. AUTOMATE FT Motor

**IDLER HOUSING & PIN KIT**63mm ****WHILE SUPPLIES LAST****

PRICE	
CODE	RE01-0212-050063
PACK	5

COLOR. Black (050)
USE WITH. 63mm Tube, Zipscreen Reducer, Idler Bracket

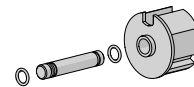
**STAINLESS STEEL RIVET**

0.16" O.D [Grip Range 0.126" - 0.189"]

PRICE	
CODE	HD86-0332-010009
PACK	100

COLOR. Stainless Steel (010)
USE WITH. Zipscreen U Mounting Rail, Zip Inner Rail, L Fixing Rail

**UNIVERSAL ZAMAK ADAPTER**

with Lock Ring & screws

PRICE	
CODE	RB56-0762-014050
PACK	1

COLOR. Cast Silver (014)
USE WITH. Extreme Square Motor Bracket Plate, AX Motors

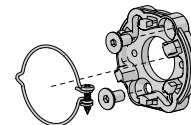
**SOMFY DRIVE WHEEL**

TYPE	63mm	78mm
PRICE		
CODE	RE01-0663-050003	RE01-0678-050003
PACK	5	5

COLOR. Black (050)
USE WITH. M50 Somfy Round Head Motor

**UNIV ZAMAK ADAPTER & LOCK RING**

M6 x 10mm (open brackets)

TYPE	Universal
PRICE	
CODE	RB56-0763-014050
PACK	1

COLOR. Cast Silver (014)
USE WITH. Open Brackets

**UNIV ZAMAK ADAPTER & LOCK RING**

M6 X 12mm (boxed system)

TYPE	Universal
PRICE	
CODE	RB56-0764-014050
PACK	1

COLOR. Cast Silver (014)
USE WITH. Box 120 system

**ULTRA LOCK SEAL V3**

164ft (50m) Roll

PRICE	
CODE	SB91-0008-050050
PACK	50

COLOR. Black (050)
USE WITH. Zipscreen Ultra-Lock V2, F56 Weight Bar, F72 HD Weight Bar

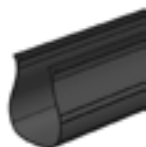

SPARE PARTS

BOX 120 END PLATE - O-RING, EPDM, METRIC, 6.0 ID X 3.0 CS

PRICE	
CODE	HD87-1060-050030
PACK	1000

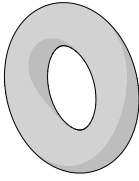

COLOR. Black [050]
 USE WITH. BOX 120 End Plates (RE01-1101-xxx120)

BOX 120 END PLATE COVER, BLACK

PRICE	
CODE	ME01-1101-050905
PACK	4



COLOR. Black [050], Pure White [069]
 USE WITH. BOX 120 End Plates (RE01-1101-xxx120)

IDLER/SPRING ADAPTER MKII | RETAINER CLIP + SCREW

PRICE	
CODE	RE01-0214-050004
PACK	10

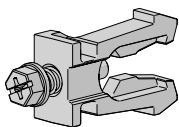

COLOR. Black [050]
 USE WITH. Idler Adaptor Kit MKII (RE01-0214-050000)

SELF-DRILLING PAINTED SCREWS

PRICE	
CODE	HD82-1923-050013
PACK	500

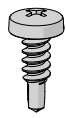

COLOR. Black [050], White [069]