

DRAPERY

SECTION 1 CURTAINS

CU21 Motorised	178
----------------	-----

SECTION 2 PANELS

CU41 Panel Glide System	182
-------------------------	-----

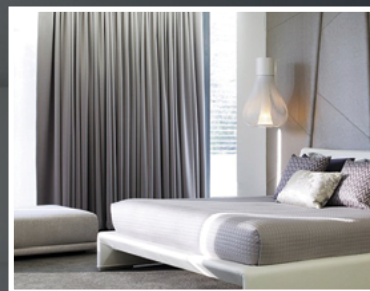

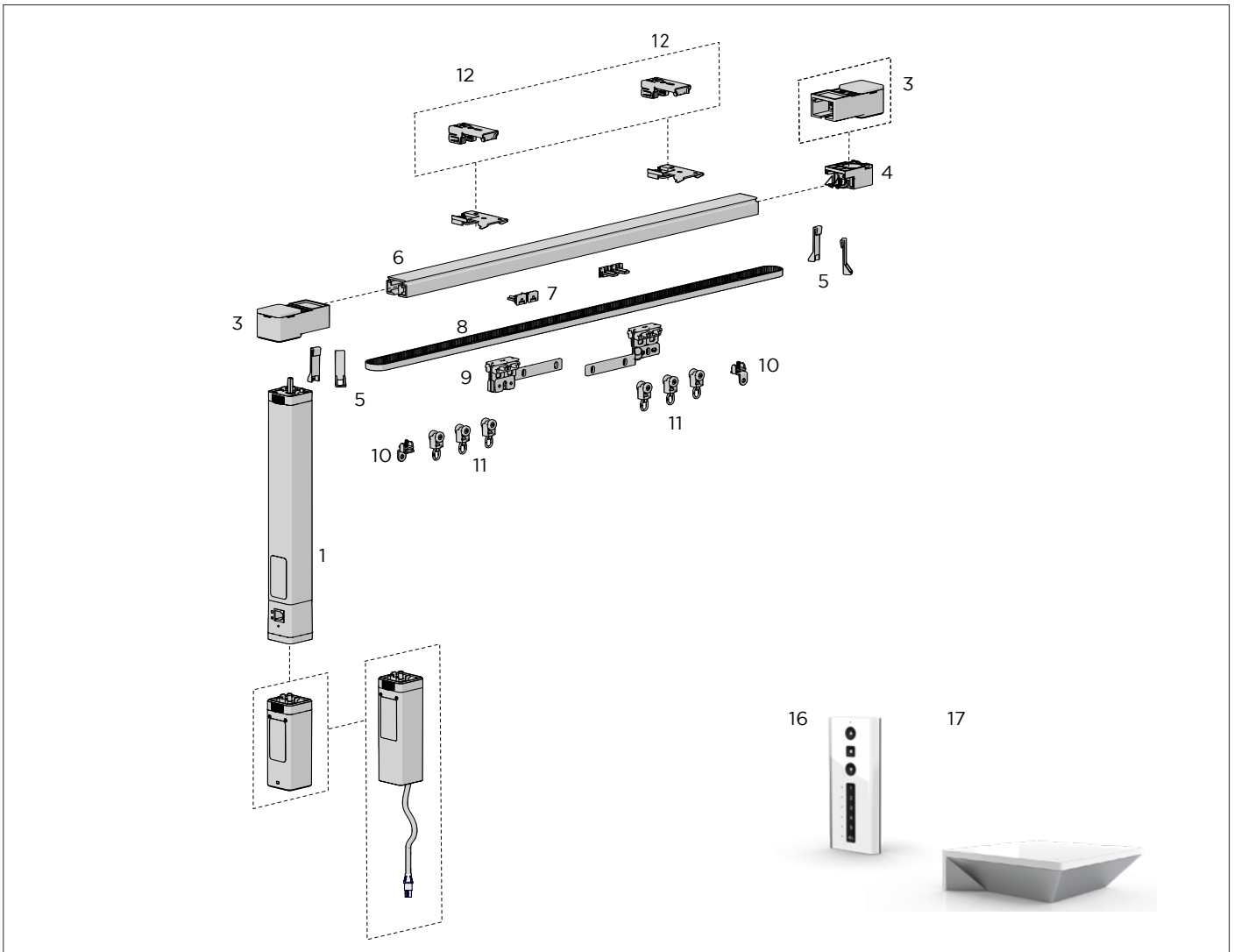

COLOUR RANGE



snow white black

PRODUCT OPTIONS

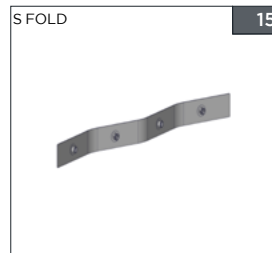
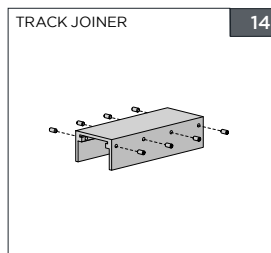
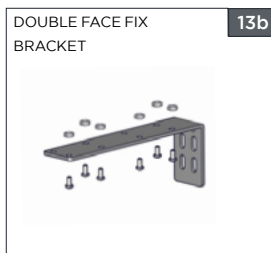
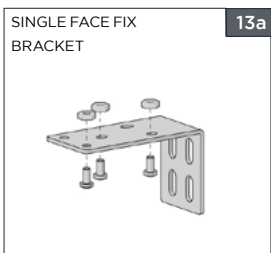

AUTOMATE | VERSA 1.2NM DRAPERY MOTOR [15V/120RPM] 1

CODE.	MT01-2101-
PACK.	1 10 Piece



COLOUR. pure white 069, black 050
USE WITH. Versa Return Pulley, Versa End Pulley

BELT FASTENING BUTTON 7

CODE.	CU21-0301-158001
PACK.	4 280 Pcs



COLOUR. white
USE WITH. Rubber belt

AUTOMATE | VERSA BATTERY PACK 2600MAH 2a

CODE.	MT03-0305-xxx004
PACK.	1 50 Pcs



COLOUR. pure white 069, black 050
USE WITH. Versa Motor

RUBBER BELT 8

CODE.	MTDR-BELT
PACK.	100 200 Rolls



COLOUR. green 158
USE WITH. Motorised curtain track

AUTOMATE | VERSA AC MODULE 2.5M CORD | 240V 2b

PRICE.	
CODE.	MT03-0305-
PACK.	1 20 Pcs



COLOUR. pure white 069, black 050
USE WITH. Versa Motor

MASTER CARRIER 9a

CODE.	CU21-0401-010020
PACK.	2 100Pcs



COLOUR. stainless steel 010
USE WITH. Curtain track, Centre open system, one way draw system

AUTOMATE | VERSA MOTOR END "S" TRACK PULLEY 3

CODE.	MT03-0401-xxx004
PACK.	10 100 Pcs



COLOUR. pure white 069, black 050
USE WITH. Versa Motor, Curtain Track

MASTER CARRIER- CURVED 9b

CODE.	CU21-0401-010021
PACK.	2 100 Pcs



COLOUR. stainless steel 010
USE WITH. Curtain track, Curve Track

AUTOMATE | VERSA RETURN "S" TRACK PULLEY 4

CODE.	MT03-0401-xxx013
PACK.	10 100 Pcs



COLOUR. pure white 069, black 050
USE WITH. Curtain Track

S-FOLD MASTER CARRIER OVERLAP 9c

CODE.	CU21-0401-062006
PACK.	10 100 Piece



COLOUR. White 062
USE WITH. Curtain Track, S-Fold System

SNAP END HOOK 5a

CODE.	CU21-0201-xxx004
PACK.	10 100 Piece



COLOUR. snow white 062, black 050
USE WITH. Versa Motor End Pulley, Versa Return End Pulley, S Fold System

S-FOLD MASTER CARRIER UNDERLAP 9d

CODE.	CU21-0401-062007
PACK.	10 100 Piece



COLOUR. White 062
USE WITH. Curtain Track, S-Fold System

END HOOK 5b

CODE.	CU21-0201-xxx003
PACK.	10 100 Pcs



COLOUR. snow white 062, black 050
USE WITH. Automate C Drive units

S-FOLD CENTRE OPENING ARM 9e

CODE.	CU21-0410-010001
PACK.	10 100 Piece

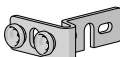

COLOUR. stainless steel 010
USE WITH. S-Fold master carrier body, S-Fold conn. runner row, S-fold snap tape

CURTAIN TRACK
5.8m length 6

CODE.	CU21-0101-xxx580
PACK.	10 240 Lgth

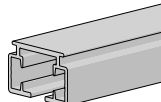

COLOUR. pure white 069, black 050
USE WITH. All Curtain Track Components

S-FOLD MASTER CARRIER BODY 9f

CODE.	CU21-0410-069003
PACK.	10 100 Kit

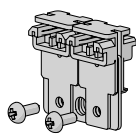

COLOUR. pure white 069
USE WITH. S-Fold Centre Opening Arm, Curtain Track

HOOK END STOPPER 10a

CODE.	CU21-0401-010010
PACK.	2 400 Pcs

COLOUR. stainless steel 010
USE WITH. Curtain Track and Pulley



S-FOLD SNAP TAPE 15
1 Roll = 91.44 metres | 108mm pitch

CODE.	CU21-0401-062004
PACK.	1 4 Roll

COLOUR. snow white 062
USE WITH. Connected Runner, Snap Button Pendant



END STOPPER 10b

CODE.	CU21-0401-010009
PACK.	10 400 Piece

COLOUR. Silver ZINC plated 025
USE WITH. Curtain Track



S-FOLD CONNECTED RUNNER ROW -
1 Row = 30 metres (500 pieces) | 60mm pitch

CODE.	CU21-0401-xxx015
PACK.	1 9 Roll

COLOUR. snow white 062, black 050
USE WITH. Curtain Track, Pendant



RUNNERS 11

CODE.	CU21-0401-xxx001
PACK.	50 300 Pcs

COLOUR. snow white 062, black 050
USE WITH. Curtain Track



SNAP BUTTON PENDANT -

CODE.	CU21-0401-xxx013
PACK.	100 500 Piece

COLOUR. snow white 062, black 050
USE WITH. S-fold Connected Runner Row, Snap Tape



TOP/ CEILING FIX BRACKET 12a

CODE.	CU21-0501-xxx001
PACK.	10 100 Pcs

COLOUR. snow white 062, black 050
USE WITH. Curtain track, Ceiling fix bracket



HOOK PENDANT -

CODE.	CU21-0401-xxx005
PACK.	37 370 Pcs

COLOUR. snow white 062, black 050
USE WITH. S-Fold connected runner,



AUTOMATE | DRAPE CEILING MOUNT CLIP 12b

CODE.	MT03-0401-
PACK.	20 200 Pcs

COLOUR. pure white 069, black 050
USE WITH. Curtain Track

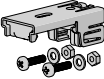

AUTOMATE REMOTES 8
One Channel, Five Channel & Fifteen Channel



SIZE.	Push ONE Channel	Push 5 Channel
CODE.	MT02-0101-xxx010	MT02-0101-xxx004
PACK.	1 20 Pcs	1 100 Pcs
SIZE.	Push 15 Channel	
CODE.	MT02-0101-xxx008	
PACK.	1 100 Pcs	

COLOUR. white 067, black 050
USE WITH. Automate Motors

SINGLE FACE FIX BRACKET 13a

CODE.	CU21-0501-xxx002
PACK.	10 100 Pcs

COLOUR. snow white 062, black 050
USE WITH. Ceiling Fix Bracket

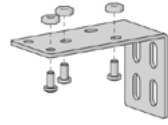

AUTOMATE PULSE 2 17

CODE.	MT02-0401-067001
PACK.	1 10 Piece

COLOUR. white 067
USE WITH. Automate Versa Motor



DOUBLE FACE FIX BRACKET 13b

CODE.	CU21-0501-062003
PACK.	10 50 Pcs

COLOUR. snow white 062
USE WITH. Ceiling Fix Bracket

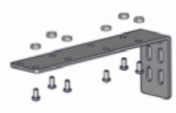

TRACK JOINER 14

CODE.	CU21-0601-xxx000
PACK.	1 20 Pcs

COLOUR. snow white 062, black 050
USE WITH. Curtain Track

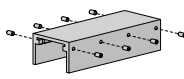

5V 2A WALL CHARGER & 4M USB CABLE | AU -

CODE.	MT03-0301-069016
PACK.	1 50 Set

COLOUR. pure white 069
USE WITH. Versa Motor

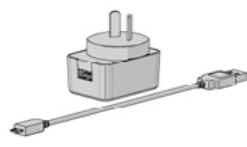

USB MICRO B TO MALE EXTENSION CABLE 4M

CODE.	MT03-0301-069007
PACK.	1 100 Piece



COLOUR. white 069
 USE WITH. Versa Battery Module, USB Wall Charger Plug

5V 2A WALL CHARGER PLUG | AU

CODE.	MT03-0301-069011
PACK.	1 100



COLOUR. white 069
 USE WITH. Versa Motor, Micro USB Cable

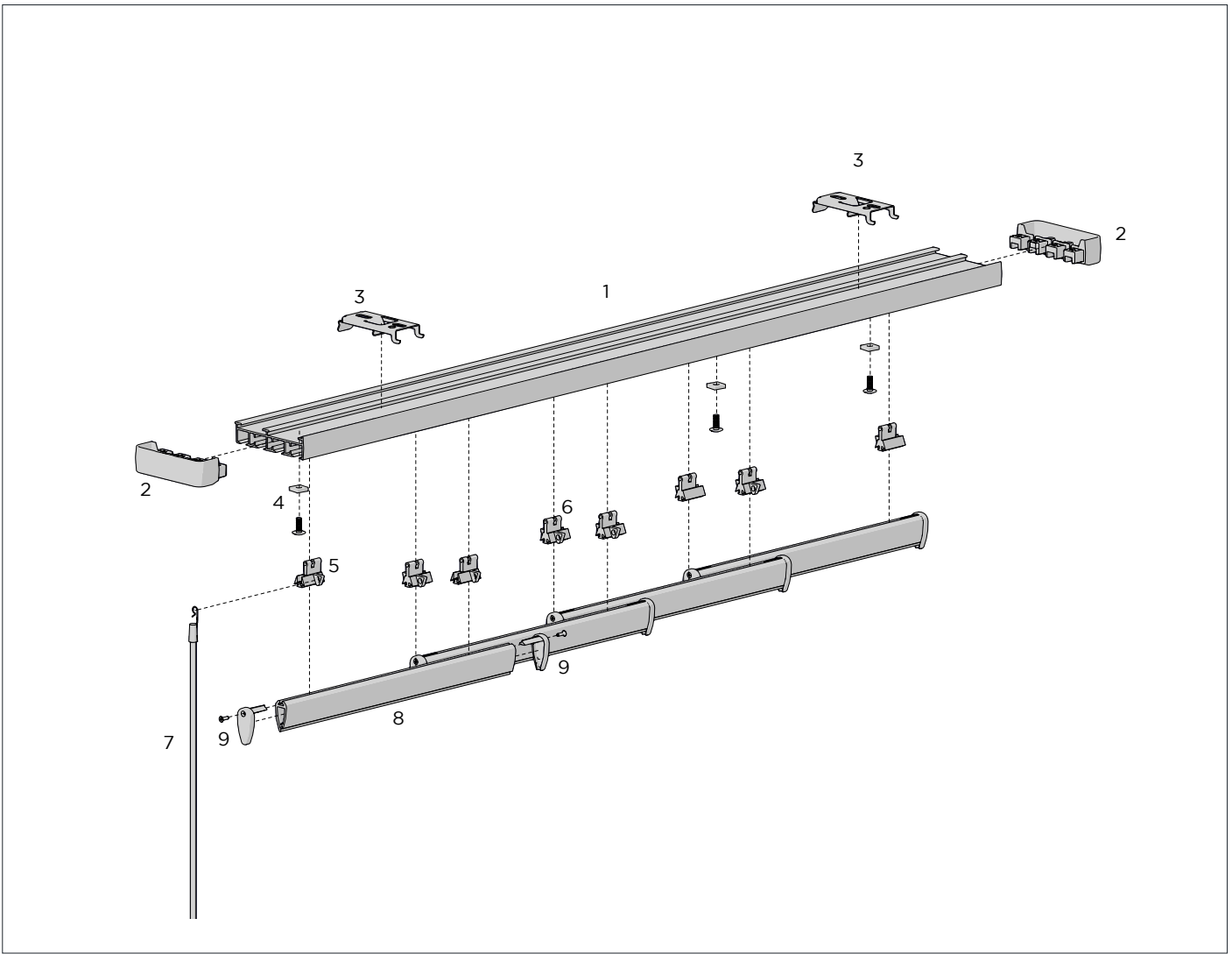

COLOUR RANGE



SYSTEM OPTIONS

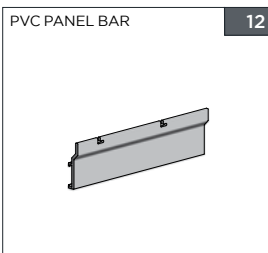
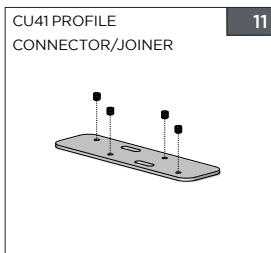
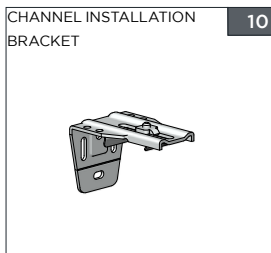

ADD ON SYSTEMS



CU41 ALUMINIUM PROFILE | 3 CHANNEL
49 x 16mm x 5m length 1a

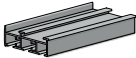

TYPE.	nat. anodised	colours - refer below
CODE.	CU41-0243-020500	CU41-0243-xxx500
PACK.	5 105 Lgths	5 105 Lgths

COLOUR. pure white 069, black 050, sandstone 269
USE WITH. CU41 End Caps - 3 Channel, Installation Bracket - 2 & 3 Channel

CU41 ALUMINIUM PROFILE | 4 CHANNEL
67 x 16mm x 5m length 1b

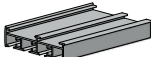

TYPE.	nat. anodised	colours - refer below
CODE.	CU41-0244-020500	CU41-0244-xxx500
PACK.	5 90 Lgths	5 90 Lgths

COLOUR. pure white 069, black 050, sandstone 269
USE WITH. CU41 End Caps - 4 Channel, Installation Bracket - 4 & 5 Channel

CU41 ALUMINIUM PROFILE | 5 CHANNEL
85 x 16mm x 5m length 1c

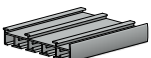

TYPE.	nat. anodised 020	colours - refer below
CODE.	CU41-0245-020500	CU41-0245-xxx500
PACK.	5 75 Lgths	5 75 Lgths

COLOUR. pure white 069, black 050, sandstone 269
USE WITH. CU41 End Caps - 5 Channel, Installation Bracket - 4 & 5 Channel

CU41 END CAPS + FIXING SCREWS | 3 CHANNEL 2a

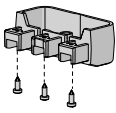

CODE.	CU41-0423-xxx003
PACK.	50 500 Set

COLOUR. black 050, pure white 069, grey VE 350, sandstone 269
USE WITH. CU41 Aluminium Profile - 3 Channel

CU41 END CAPS + FIXING SCREWS | 4 CHANNEL 2b

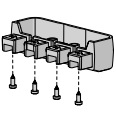

CODE.	CU41-0424-xxx004
PACK.	50 500 Set

COLOUR. black 050, pure white 069, grey VE 350, sandstone 269
USE WITH. CU41 Aluminium Profile - 4 Channel

CU41 END CAPS + FIXING SCREWS | 5 CHANNEL 2c

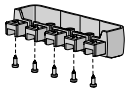

CODE.	CU41-0425-xxx005
PACK.	50 500 Set

COLOUR. black 050, pure white 069, grey VE 350, sandstone 269
USE WITH. CU41 Aluminium Profile - 5 Channel

CU40 SLIMLINE PANEL END CAP + SCREWS | 3, 4, 5 CH. 2d



CODE.	CU40-0420-xxx000
PACK.	50 500 Set

COLOUR. black 050, pure white 069, silver grey 338
USE WITH. CU41 Aluminium Profile - 3-5 Channel

CU40 SLIMLINE END CAP COVER | 3, 4, 5 CH. 2e



CODE.	CU40-0430-069000
PACK.	50 500

COLOUR. black 050, pure white 069, silver grey 338
USE WITH. CU40 Slimline End cap

4-5 CHANNEL INSTALLATION BRACKET | TOP/CEILING FIX 3a



CODE.	CU41-0575-025002
PACK.	50 1000 Pcs

COLOUR. zinc plated 025 only
USE WITH. CU41 Aluminium Profile - 4 & 5 Channel

2-3 CHANNEL INSTALLATION BRACKET | TOP/CEILING FIX 3b



CODE.	CU41-0535-025001
PACK.	50 2000 Pcs

COLOUR. zinc plated 025 only
USE WITH. CU41 Aluminium Profile - 2 & 3 Channel

PANEL BAR FIXING NUT & BOLT 4



CODE.	CU41-0801-020000
PACK.	100 2000 Sets

COLOUR. silver 020 only
USE WITH. CU41 Aluminium Profile - 2, 3, 4 & 5 Channel

CU41 ROLLER CAR ONE SIDE + screw 5



CODE.	CU41-0601-xxx000
PACK.	100 1000 Piece

COLOUR. natural white 060, black 050, silver grey 338
USE WITH. Spline Aluminium Panel Bar

CU41 ROLLER CAR TWO SIDE + screw 6



CODE.	CU41-0602-xxx000
PACK.	100 1000 Piece

COLOUR. natural white 060, black 050, silver grey 338
USE WITH. Spline Aluminium Panel Bar

STEEL FLICK ROD | WIRE HOOK 7a



TYPE.	100cm	125cm	150cm
CODE.	CU40-3121-069100	CU40-3121-069125	CU40-3121-069150
PACK.	10 100 Lgths	10 100 Lgths	10 100 Lgths

COLOUR. pure white 069 only
USE WITH. Roller Car

PANEL BAR END CAPS + SCREW UNIVERSAL 9a

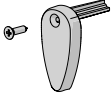

CODE.	CU41-0283-xxx000
PACK.	100 5000 Pcs

COLOUR. black 050, pure white 069, sandstone 269, silver grey 338
USE WITH. Spline Panel Bar

SELF TAPPING PHILIPS HEAD M2 x 8mm 9b



CODE.	HD82-1914-025008
PACK.	100 1000 Pcs

COLOUR. silver zinc plated 025
USE WITH. Panel Bar End Caps

ACRYLIC FLICK ROD | WIRE HOOK 7b



TYPE.	100cm	125cm	150cm
CODE.	CU40-3122-001100	CU40-3122-001125	CU40-3122-001150
PACK.	10 100 Pcs	10 100 Pcs	10 100 Pcs

COLOUR. clear 000 only
USE WITH. Roller Car

2-3 CHANNEL INSTALLATION BRACKET | FACE/WALL FIX 10a

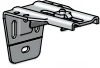

TYPE.	Zinc Plated	Colours - refer below
CODE.	CU41-1535-025003	CU41-1535-xxx003
PACK.	25 200 Pcs	25 200 Pcs

COLOUR. black 050, pure white 069, sandstone 269
USE WITH. CU41 Aluminium Profile - 2 & 3 Channel

4-5 CHANNEL INSTALLATION BRACKET | FACE/WALL FIX 10b

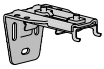

TYPE.	Zinc Plated	Colours - refer below
CODE.	CU41-1575-025004	CU41-1575-xxx004
PACK.	25 200 Pcs	25 200 Pcs

COLOUR. black 050, pure white 069, sandstone 269
USE WITH. CU41 Aluminium Profile - 4 & 5 Channel

ALUMINIUM PANEL BAR 8

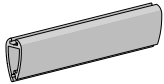

TYPE.	nat. anodised 020	colours - refer below
CODE.	CU41-0201-020500	CU41-0201-xxx500
PACK.	10 240 Lgths	10 240 Lgths

COLOUR. black 050, pure white 069, sandstone 269
USE WITH. Spline Panel Bar End Caps, Spline - Flat 9mm

2-3-4 CHANNEL CU41 PROFILE CONNECTOR/JOINER + Screws 11a

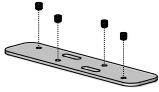

CODE.	CU41-2002-025234
PACK.	10 100 Sets

COLOUR. ZINC plated silver 025 only
USE WITH. CU41 Aluminium Profile - 2, 3 & 4 Channel

5 CHANNEL CU41 PROFILE CONNECTOR/JOINER + Screws 11b

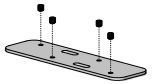

CODE.	CU41-2005-025005
PACK.	10 100 Sets

COLOUR. ZINC plated silver 025 only
USE WITH. CU41 Aluminium Profile - 5 Channel

9MM ACM FLAT SPLINE - NO TAPE -
100 Lm Roll

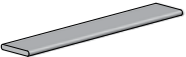

TYPE.	No Tape
CODE.	RB92-0901-001100
PACK.	1 10 rolls

COLOUR. natural 001 only
USE WITH. Spline Panel bar

PVC PANEL BAR - DELUXE ROLLER TRAVELLER 12a



CODE.	CU40-0348-069001
PACK.	200 1000 Pcs

COLOUR. pure white 069 only
USE WITH. PVC Panel Bar

9MM ACM FLAT SPLINE - WITH DOUBLE SIDED TAPE -
Double Sided MP-HR Tape | 75 Lm Roll

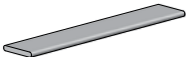

TYPE.	One Side	Two Sides
CODE.	RB92-0902-001075	RB92-0903-001075
PACK.	1 10 rolls	1 10 rolls

COLOUR. natural 001 only
USE WITH. Spline Panel bar

PVC PANEL BAR - T ANGLE STOP + screw 12b



CODE.	CU40-0602-069000
PACK.	100 1000 Sets

COLOUR. pure white 069 only
USE WITH. PVC Panel Bar

PVC PANEL BAR - L ANGLE STOP 12c
 + screw

CODE.	CU40-0601-069000
PACK.	100 1000 Sets



COLOUR. pure white 069 only
 USE WITH. PVC Panel Bar

PVC PANEL BAR 12d
 with Hook Touch Tape

CODE.	CU40-0247-062400
PACK.	5 30 Lgths

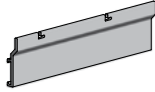

COLOUR. snow white 062 only
 USE WITH. CU41 Aluminium Profile - 2, 3, 4 & 5 Channel, Deluxe Roller Traveller

PVC PANEL FABRIC STIFFENING TAPE 12e
 25mm x 100m

CODE.	CU40-0901-069025
PACK.	50 1000 Metre

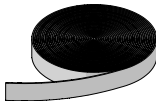

COLOUR. pure white 069 only
 USE WITH. PVC Panel Bar

TOUCH TAPE SEW-ON | LOOP 25MM 12d
 1 Roll = 25Lm

CODE.	HD31-0125-060025
PACK.	1 10 Rolls

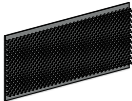

COLOUR. natural white 060 only
 USE WITH. Touch Tape HOOK